

# XT-1

## XTENDED RANGE SINGLE CHANNEL SUPERVISED STATIONARY TRANSMITTER

For Use With Linear's  
XR Series Xtended  
Range Receivers

### Installation Instructions

**WARNING: THIS PRODUCT SHOULD NOT BE USED IN LIFE SAFETY APPLICATIONS.**  
FCC Rules allow unlicensed high-power transmissions at or near the operating frequency of this product which may interfere with, or even disable, normal operation of this radio device.

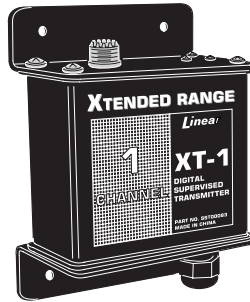

# Linear

(760) 438-7000  
USA & Canada (800) 421-1587 & (800) 392-0123  
Toll Free FAX (800) 468-1340  
www.linearcorp.com

## 1. PRODUCT DESCRIPTION

Linear's Xtended Range FM transmitters and receivers are designed for use in various wireless remote control applications. When triggered with an external switch, the Model XT-1 transmitter will send a 10 watt, 27.255 MHz, digital encoded, FSK modulated, signal to its companion receiver. The receiver will verify the digital code, activate its output, and trigger the remote device.

The XT-1 transmitter has full supervision capabilities. If the "status" option is selected, the XT-1 sends hourly status signals to its receiver. If these signals cease, the receiver will indicate trouble by activating its status output after four hours. Contact supervision allows the receiver's output to follow the transmitter's input, staying activated as long as the transmitter input is activated. Alternately, an "auto-restore" option can be selected, causing a momentary receiver output each time the transmitter is activated. Either a N/O or N/C input (jumper selectable) can trigger the transmitter.

Power for the XT-1 transmitter can come from an external regulated 12 VDC, 2-Amp power supply (Linear Model T-1224DC) or from a 12-volt battery. A 3-amp fuse protects the unit from reverse power polarity. The XT-1 draws about 15  $\mu$ A standby, and about two amps during transmissions. If the power supply voltage drops below 10.5 volts, a low battery message will be included with any signal transmitted, causing the receiver's low battery output to activate.

Two antennas (sold separately) are available for the XT-1. The Model ANT-1A is an 8-inch "rubber duck" antenna for short range applications (less than 1 mile). The ANT-1A requires a CON-180A (straight) connector to mate the antenna to the transmitter. For a right angle antenna, use the CON-180A plus the CON-90A. The Model ANT-2 is a 3-foot whip antenna for use in long range or difficult installations where more range from the XT-1 is required. A common 9-foot 1/4 wave CB whip antenna can also be used with the XT-1 for maximum range.

Two 8-position switches set the unit's system code. This code must be matched in the XT-1's receiver. There are 65,536 different system codes possible. The 6-position option switch selects the transmitter's channel, receiver's bank (for XR-16 receiver only), and options for status and auto-restore transmissions.

The transmitter is housed in a rugged weather-resistant metal enclosure with a sturdy SO-239 antenna connector and a water-tight wiring strain relief bushing. During transmissions, the red operation indicator (visible through a window on the case) lights. If the XT-1's input voltage is low, the indicator will blink during transmissions.

## 2. OPEN TRANSMITTER

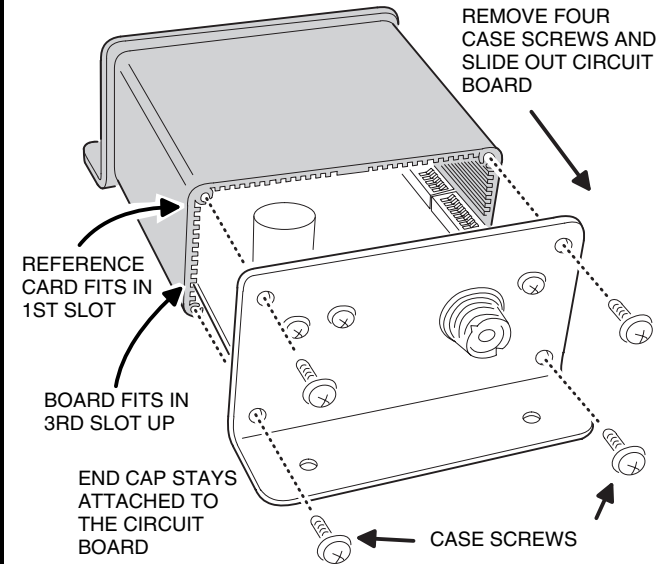

## 3. COMPONENT LOCATIONS

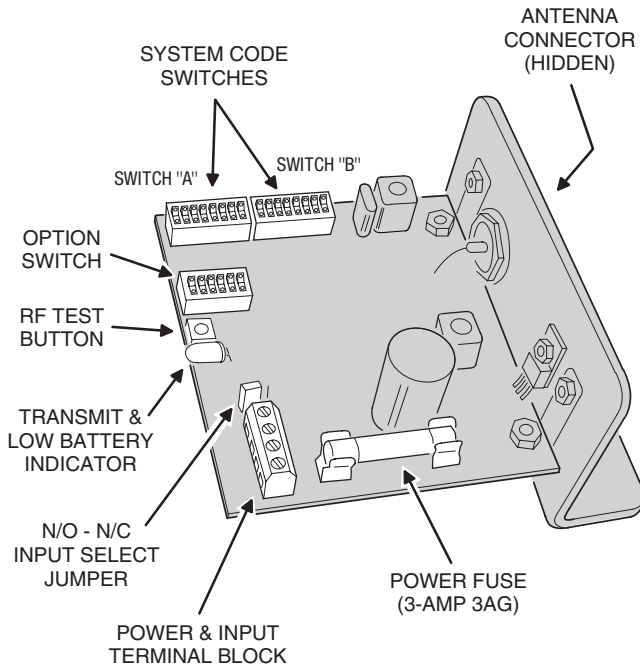

## 4. INSTALLATION TIPS

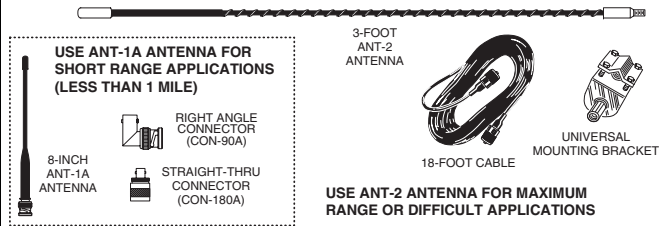

### GOOD INSTALLATION

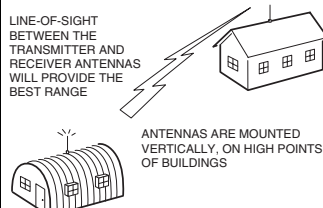

### MOUNT ANTENNA AS HIGH AS POSSIBLE

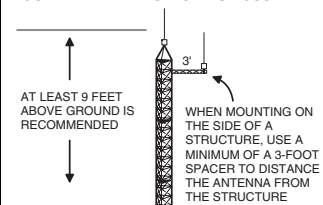

### BAD INSTALLATION

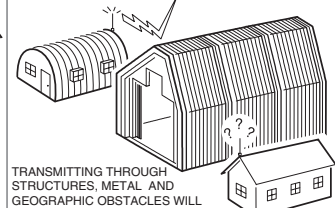

### GOOD ANTENNAS NEED GOOD GROUNDS

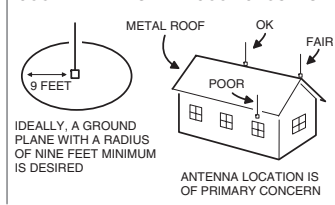

## 5. MOUNT TRANSMITTER CASE

If using the ANT-1A antenna: For best range mount the XT/XR unit to a metal plate with a minimum size of 12" x 12". The ANT-1A antenna should extend above the mounting plate and be free of obstructions. If the ANT-1A antenna cannot be mounted in the open, consider using an extension coaxial cable with PL-259 connectors to move the antenna's location. The XT/XR series of radios operate in the 27 MHz Citizens Band (CB) and may use any CB antennas or CB antenna accessories. Antennas, PL-259 extension cables and other adapters are available at Radio Shack® or other electronics stores.

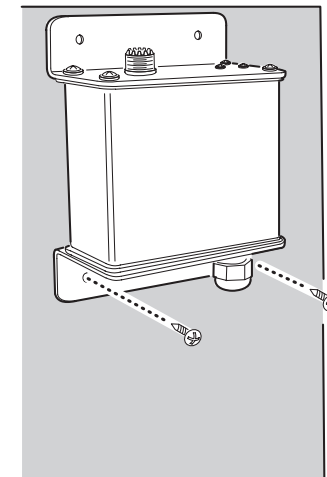

## 6. SET TRANSMITTER SWITCHES

RECEIVER CHANNEL			OPTION SWITCH			RECEIVER BANK			STATUS REPORTS		
SWITCH 1	SWITCH 2	CH #	SWITCH 3	SWITCH 4	BANK #	SWITCH 5			SWITCH 6		
OFF	OFF	1	OFF	OFF	1	OFF NO STATUS REPORTS			OFF NO STATUS REPORTS		
ON	OFF	2	ON	OFF	2	ON STATUS REPORTS			ON STATUS REPORTS		
OFF	ON	3	OFF	ON	3	OFF NO STATUS REPORTS			OFF NO STATUS REPORTS		
ON	ON	4	ON	ON	4	ON STATUS REPORTS			ON STATUS REPORTS		

SET SWITCHES 1 & 2 TO SELECT THE RECEIVER CHANNEL THE TRANSMITTER ACTIVATES (USE CHANNEL 1 FOR SINGLE CHANNEL RECEIVERS)

SET SWITCHES 3 & 4 TO SELECT THE RECEIVER BANK THE TRANSMITTER ACTIVATES (USED ONLY FOR 16 CHANNEL RECEIVER, USE BANK 1 FOR ALL OTHERS)

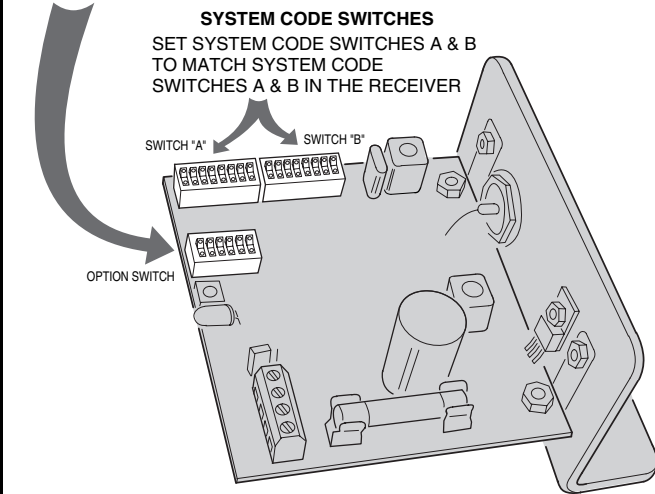

## 7. CONNECT POWER AND TRIGGER INPUTS

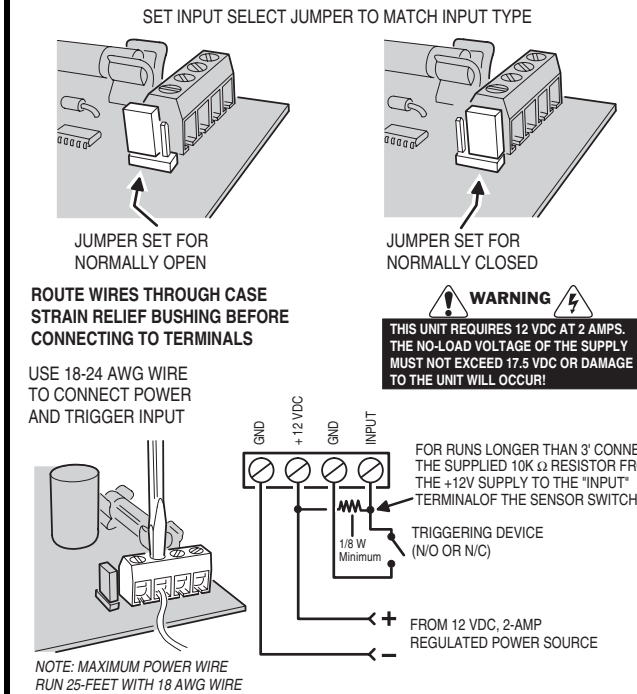

## 8. MOUNT ANTENNA AND ROUTE CABLE

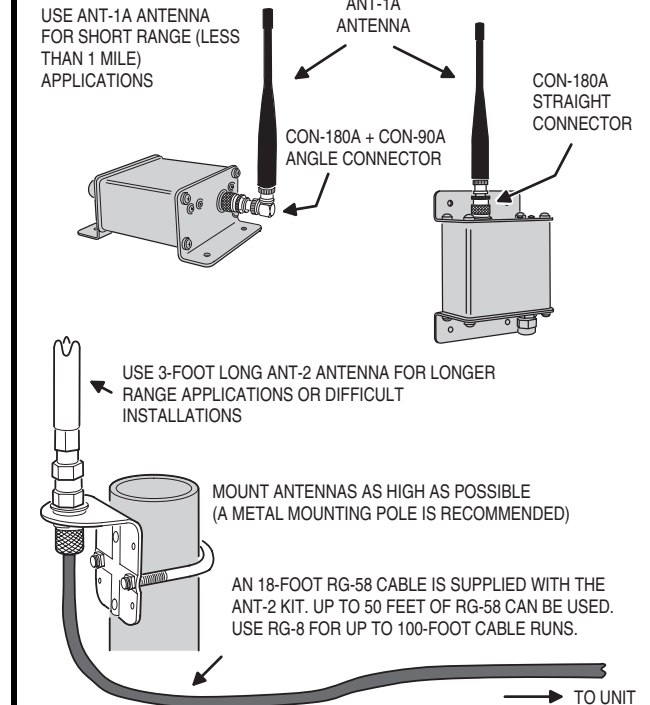

## 9. TEST SYSTEM

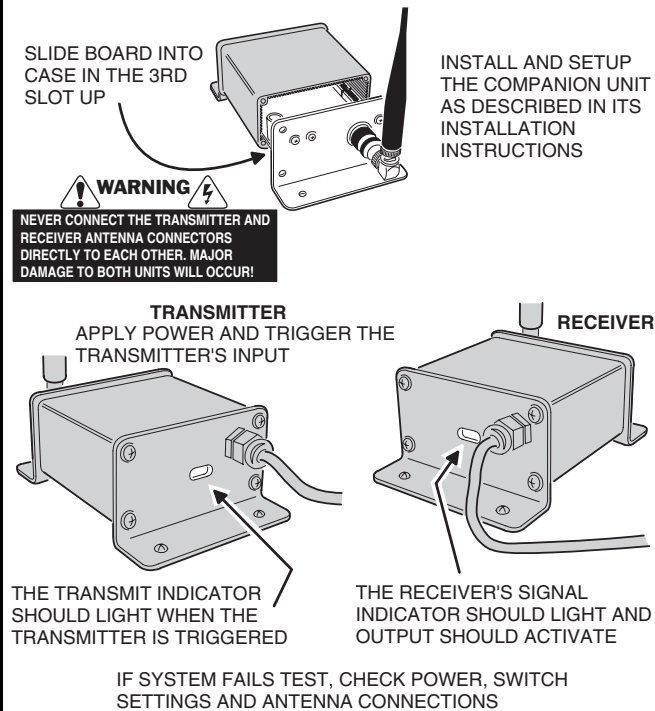

## 10. COMPLETE INSTALLATION

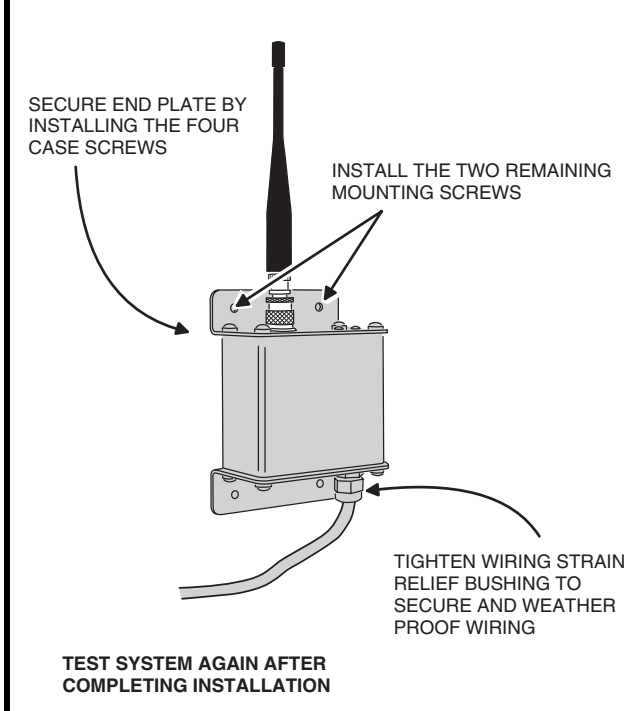

## LINEAR LIMITED WARRANTY

This Linear product is warranted against defects in material and workmanship for twelve (12) months. The Warranty Expiration Date is labeled on the product. This warranty extends only to wholesale customers who buy direct from Linear or through Linear's normal distribution channels. Linear does not warrant this product to consumers. Consumers should inquire from their selling dealer as to the nature of the dealer's warranty, if any. There are no obligations or liabilities on the part of Linear LLC for consequential damages arising out of or in connection with use or performance of this product or other indirect damages with respect to loss of property, revenue, or profit, or cost of removal, installation, or reinstallation. All implied warranties, including implied warranties for merchantability and implied warranties for fitness, are valid only until Warranty Expiration Date as labeled on the product. This Linear LLC Warranty is in lieu of all other warranties express or implied.

All products returned for warranty service require a Return Product Authorization Number (RPA#). Contact Linear Technical Services at 1-800-421-1587 for an RPA# and other important details.

### IMPORTANT !!!

Linear radio controls provide a reliable communications link and fill an important need in portable wireless signaling. However, there are some limitations which must be observed.

- \* **WARNING: THIS PRODUCT IS NOT TO BE USED IN LIFE SAFETY APPLICATIONS.** FCC Rules allow unlicensed high-power transmissions at or near the operating frequency of this product which may interfere with, or even disable, normal operation of this radio device.
- \* For U.S. installations only: The radios are required to comply with FCC Rules and Regulations as Part 95 Radio Control devices. As such, they have limited transmitter power and therefore limited range.
- \* A receiver cannot respond to more than one transmitted signal at a time and may be blocked by radio signals that occur on or near their operating frequencies, regardless of code settings.
- \* Changes or modifications to the device may void FCC compliance.
- \* Infrequently used radio links should be tested regularly to protect against undetected interference or fault.
- \* A general knowledge of radio and its vagaries should be gained prior to acting as a wholesale distributor or dealer, and these facts should be communicated to the ultimate users.